

# 本科生教学案例库建设项目图片

## 1. 粉煤灰基催化剂在烟气脱硝领域应用的相关案例图片



图 1 粉煤灰催化剂制备流程



图 2 不同形貌的粉煤灰催化剂

## 2. 粉煤灰/煤矸石基气凝胶保温材料的相关案例图片

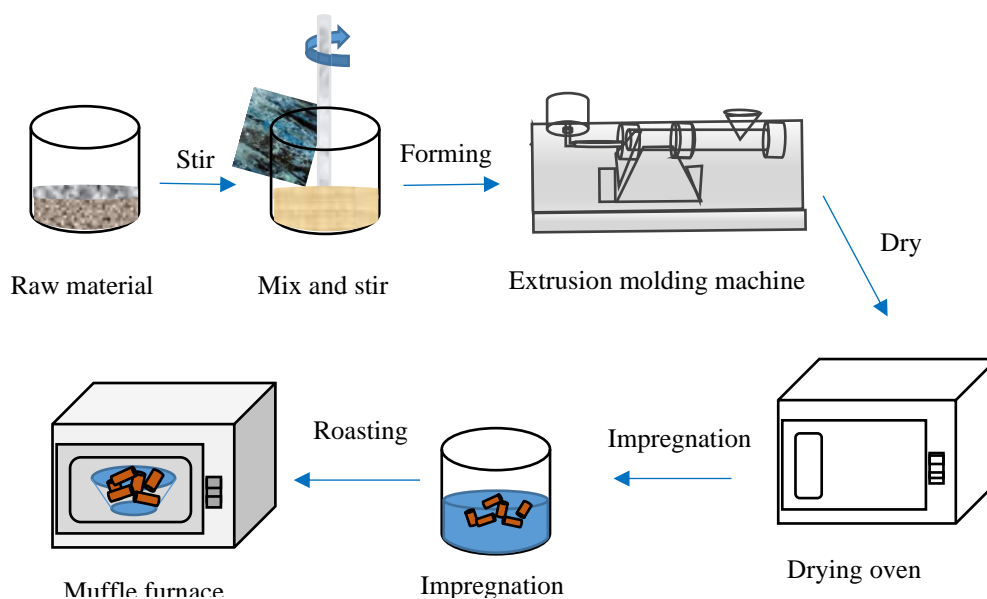

图 3 气凝胶制备流程

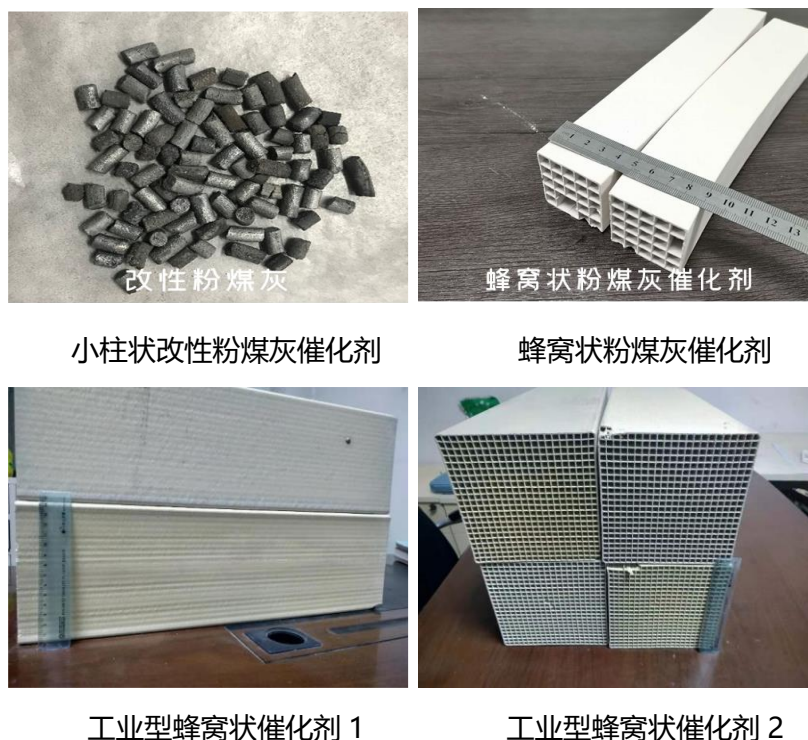

图 4 建筑保温材料

### 3. 粉煤灰/高炉矿渣基地聚物及地聚物膜的相关案例图片

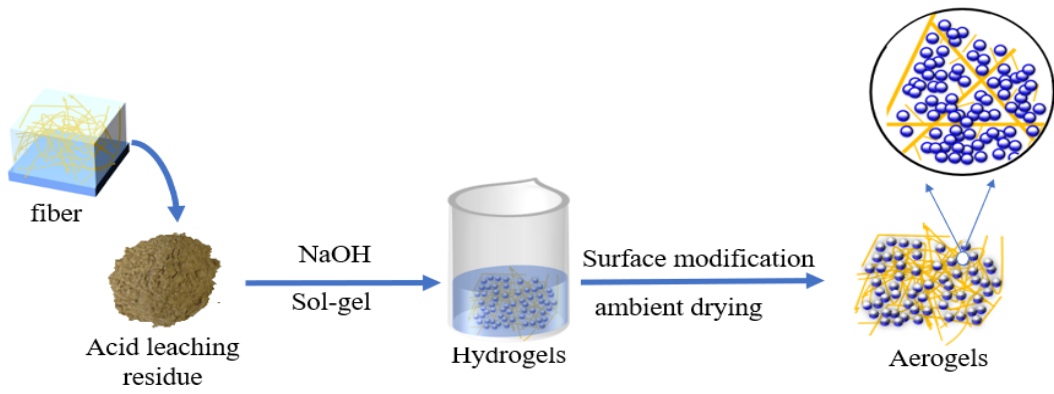

图 5 地聚物材料制备流程

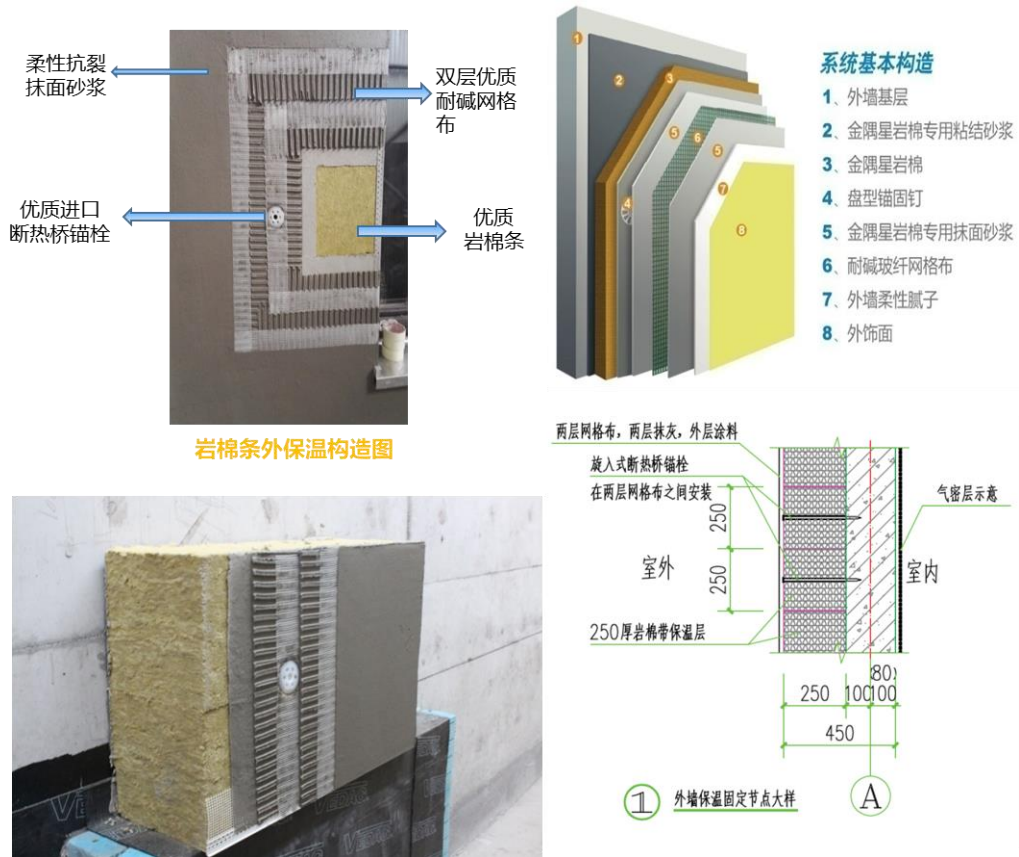

图 6 地聚物膜的制备与应用

4. 污泥污染土壤修复案例的图片

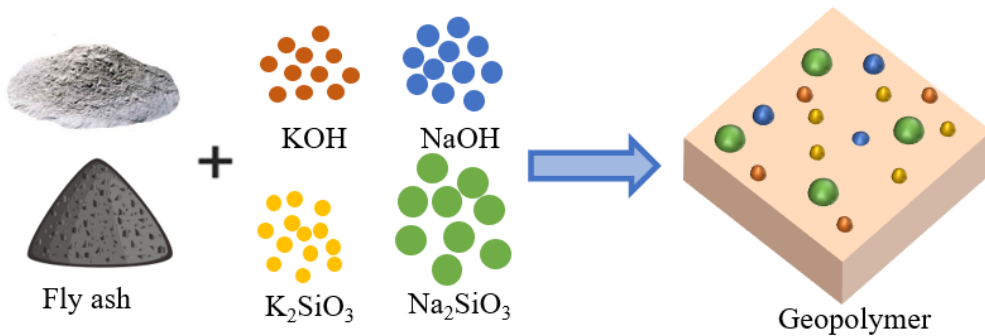

图 7 制革污泥污染土壤

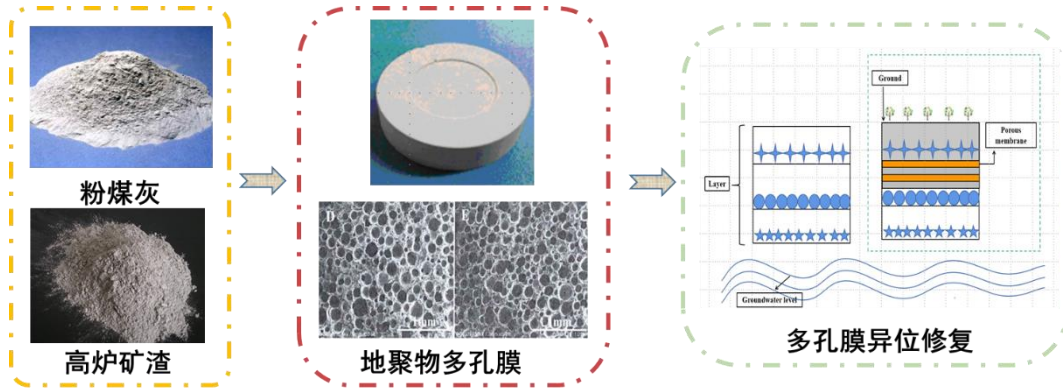

图 8 修复工艺



图 9 固化稳定化施工

5. 危险固废处理处置案例的图片

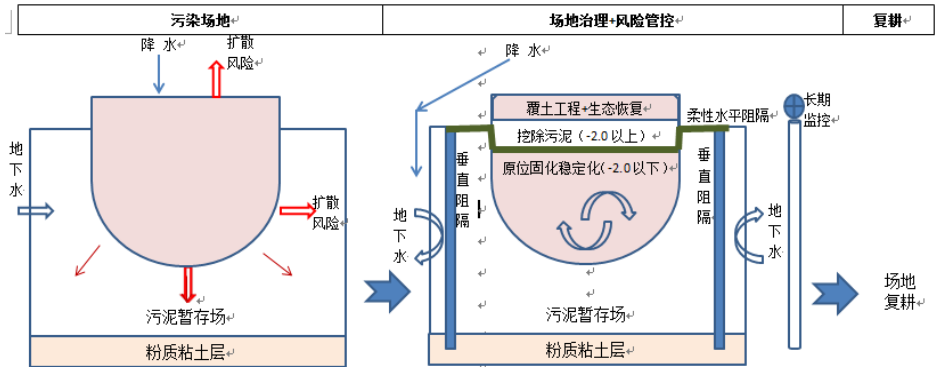

图 10 油土处理处置工艺流程图



图 11 油水分离器加盖板封闭回收 VOCs

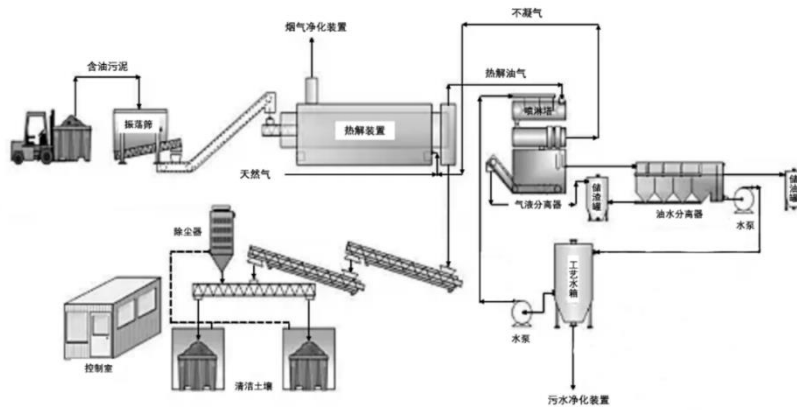

图 12 污水处理装置加盖板封闭回收 VOCs

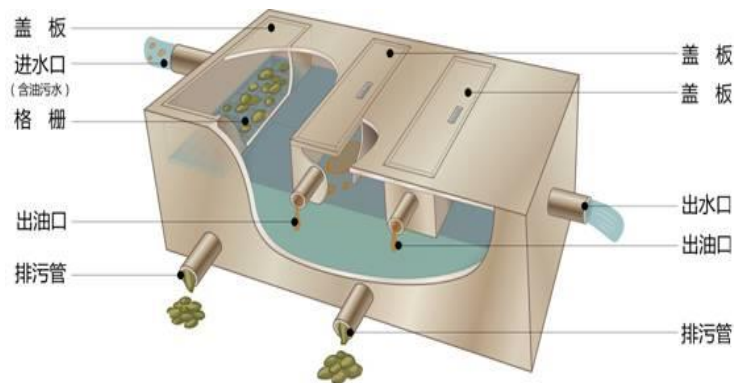

图 13 SCR 烟气脱硝系统



图 14 烟气脱硫工艺流程

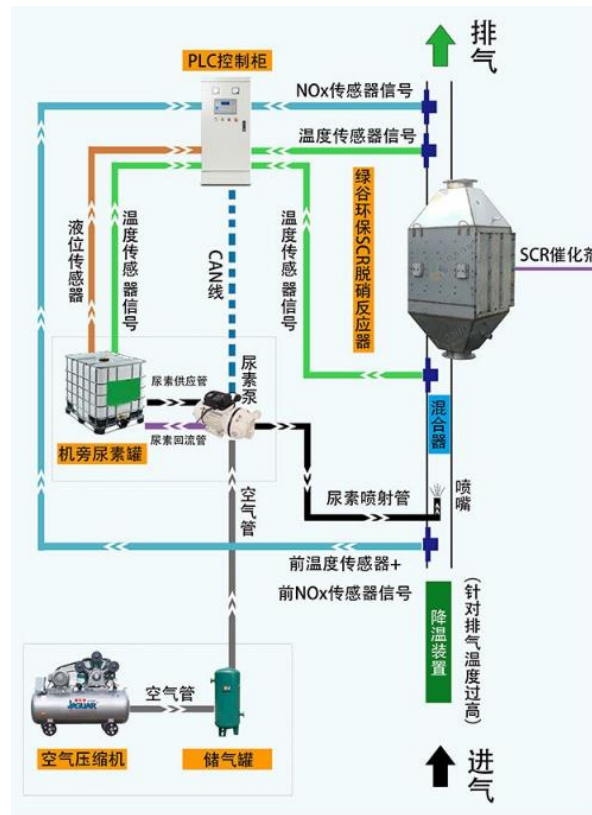

图 15 含油污水处理工艺流程

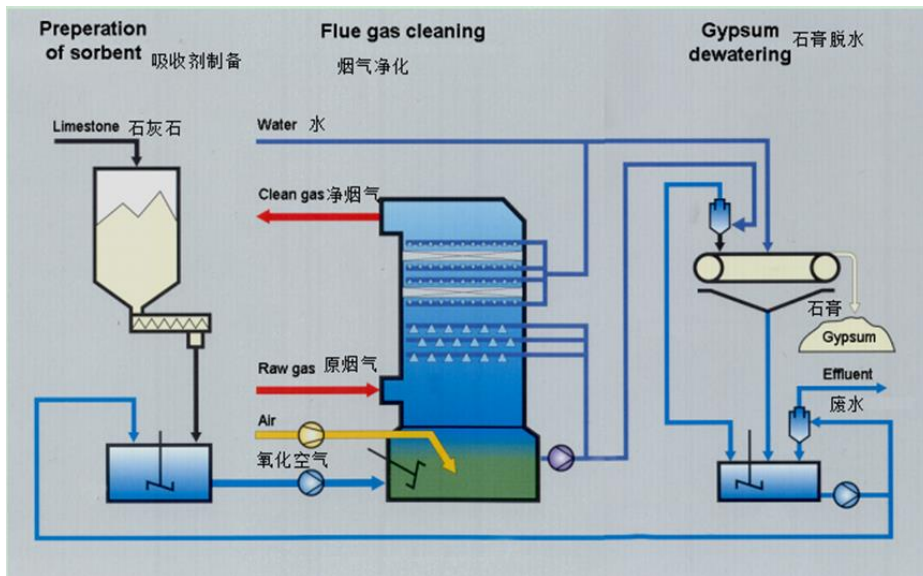

图 16 浮油设备图

6. 微波热解废盐案例的图片

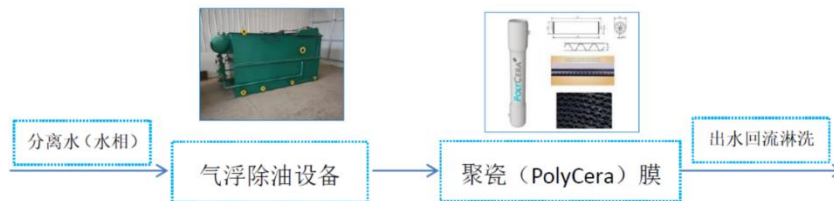

图 17 浮油设备图

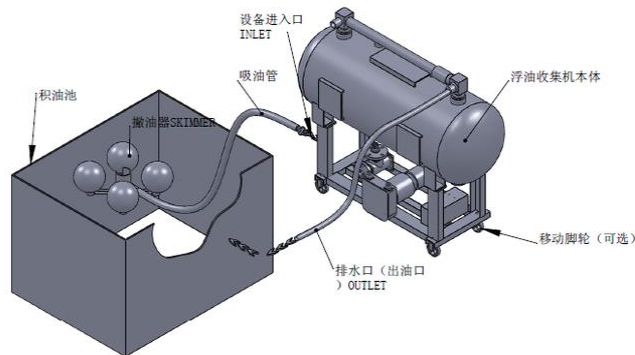

图 18 浮油设备图

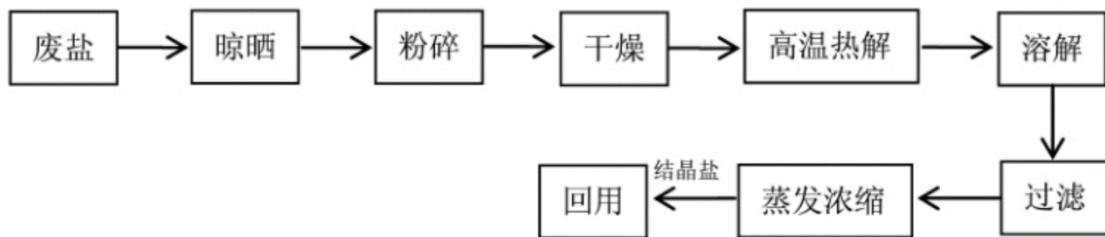

图 19 微波热解工业盐工艺流程

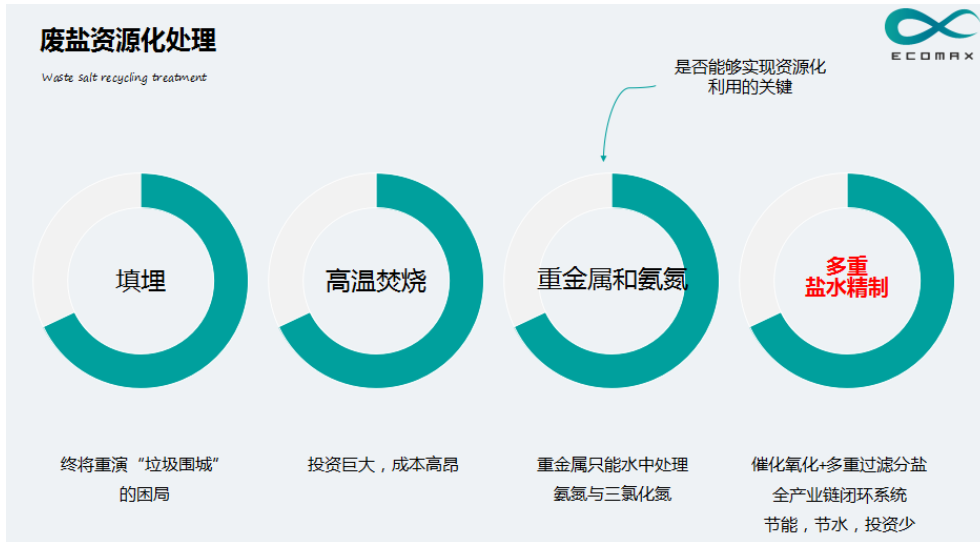

图 20 工业盐资源化应用